



# Quick Start Guide

Choose Life Without Boundaries



**Package Contents**

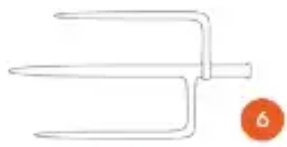
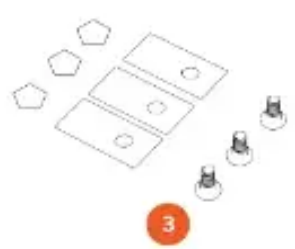
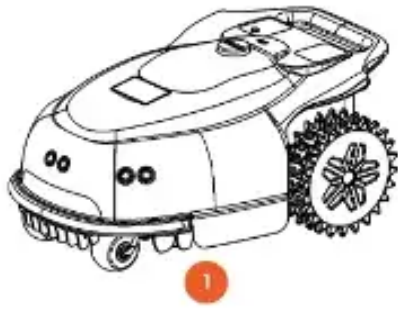

**⚠ Sharp edges. Do not point at people**



1.Mower	1x	6.Trident	1x
2.Charging station	1x	7.Support pole	1x
3.Blade	9x	8.The gps-rtk antenna	1x
4.Charger	1x	9.Quick Start Guide	1x
5.Ground nail	10x	10.Charging extension cable 10m*1	

## Parts and Functions

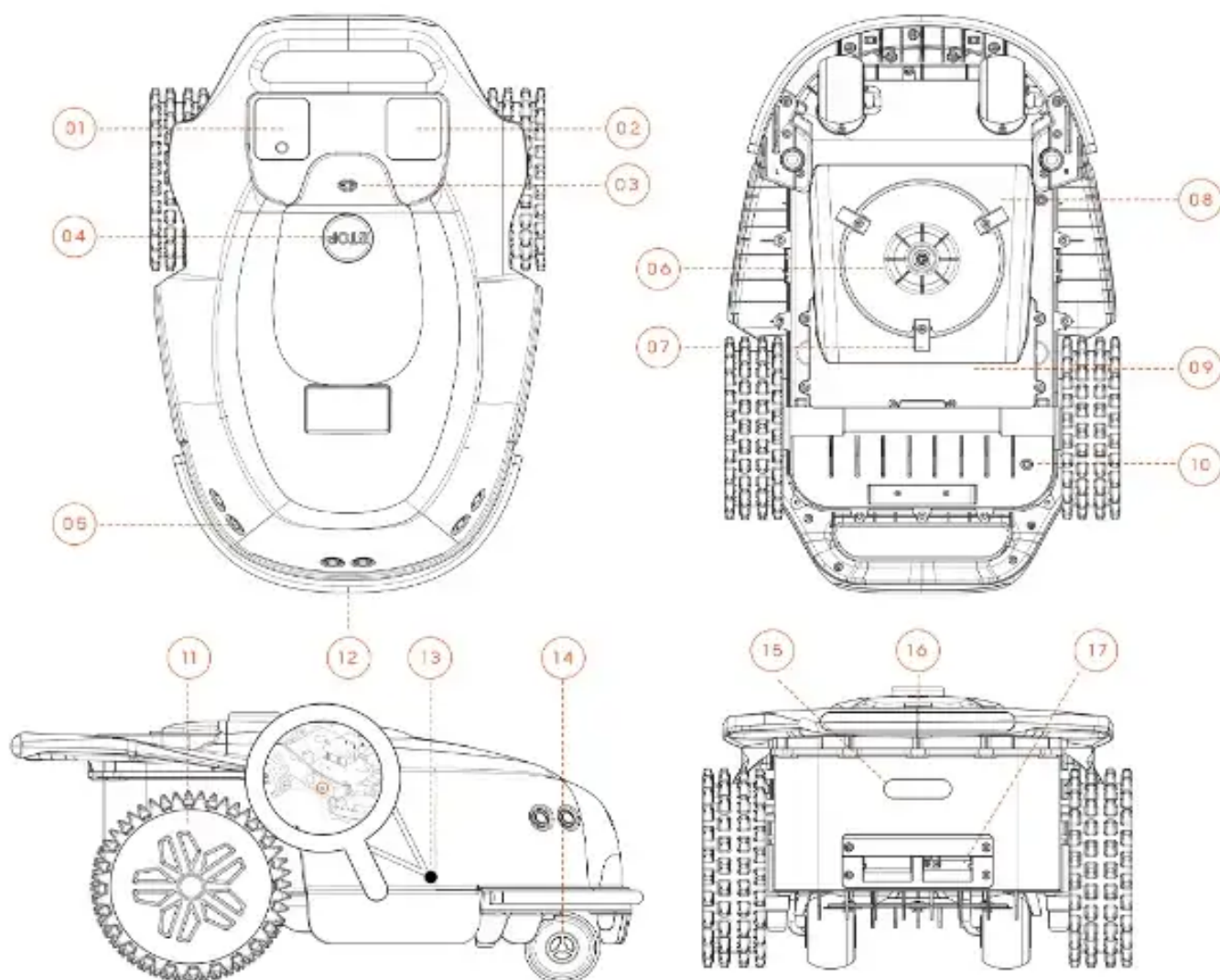

**01** Display

**02** Button panel

**03** Rain sensor

**04** Stop button

**05** Ultrasonic sensors

**06** Blade disc

**07** Blades

**08** Blade fender

**09** Battery compartment

**10** Drainage outlet

**11** Driving wheels

**12** Collision strip sensor

**13** Power switch

**14** Universal wheels

**15** Infrared sensor

**16** Handle sensing

**17** Charging port

**APP Installation** **STEP 1**

Scan the QR code to download the APP

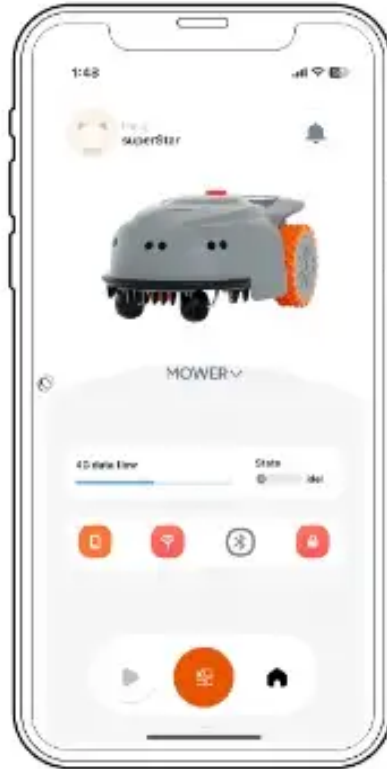

## Install the Charging Station **STEP 2**

Install the charging station and RTK antenna in a suitable location

In order to ensure that the antenna can receive good satellite signals, please remain a certain distance away (greater than 2 m) from houses, trees and walls.

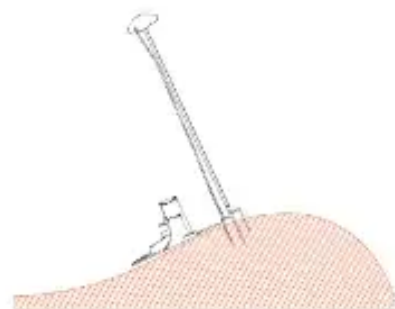
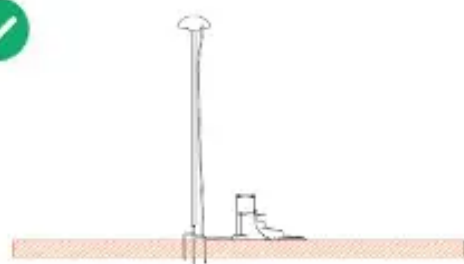
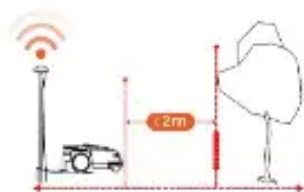

Please place the charging station on a flat non-hardened ground with the antenna upright. Do not install the antenna at an angle. Please stay away from sprinkler heads, fountains or other outdoor water systems. Please stay away from substations, generators, water pump stations and air conditioners.

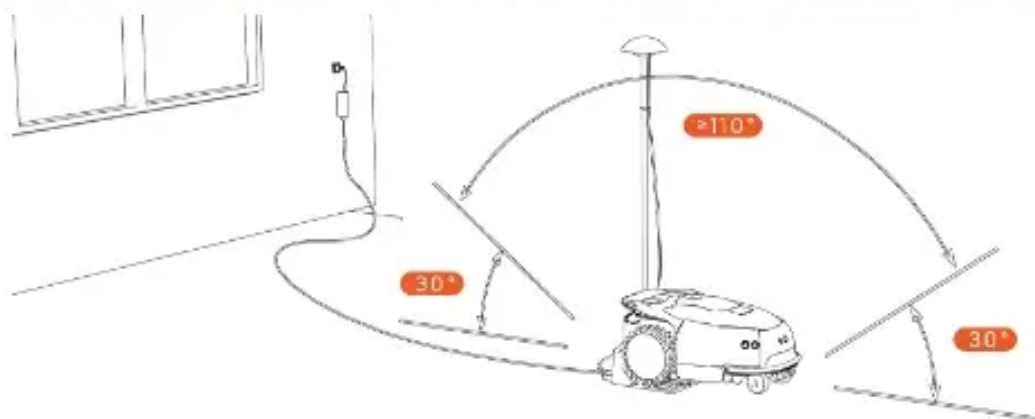

**Install the GNSS Antenna** **STEP 3**

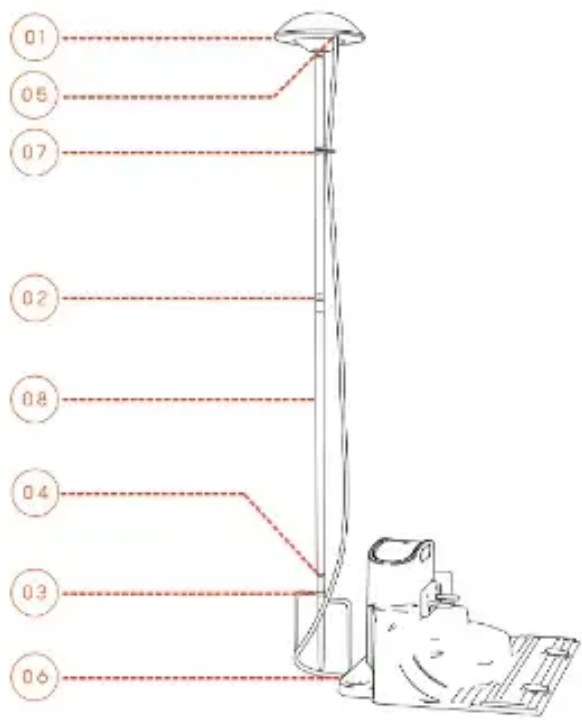

- 01** Install the RTK Antenna on the tube
- 02** Slide in the tube
- 03** Unfold the fork
- 04** Rotate onto the fork
- 05** Connect the wire with RTK Antenna
- 06** Connect with charging station
- 07** Fix the antenna
- 08** Insert into ground

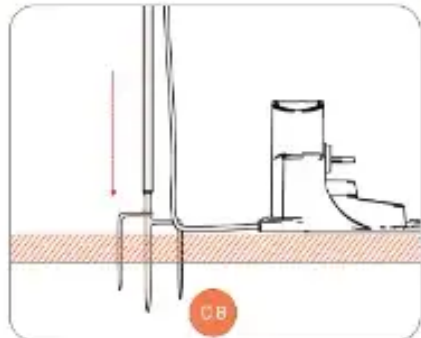
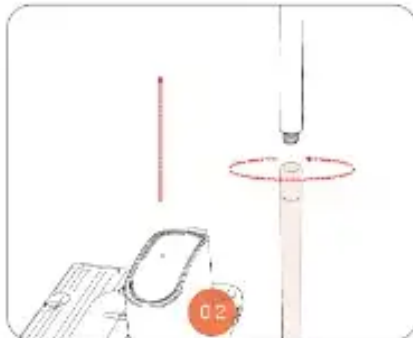



**Connect to the Power Supply** **STEP 4**

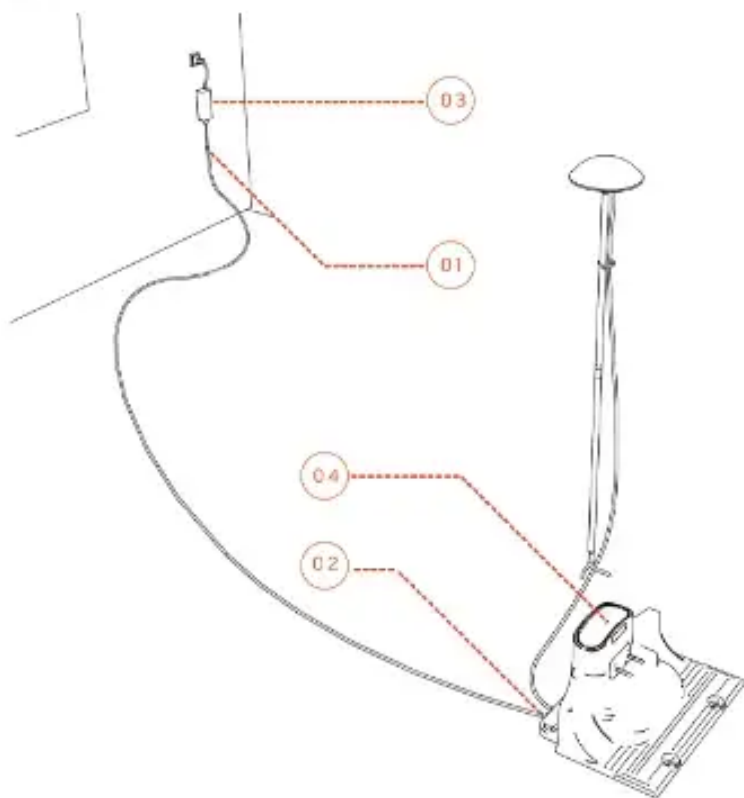

- 01** Connect the power
- 02** Connect with charging station
- 03** Insert the power plug
- 04** LED indicator

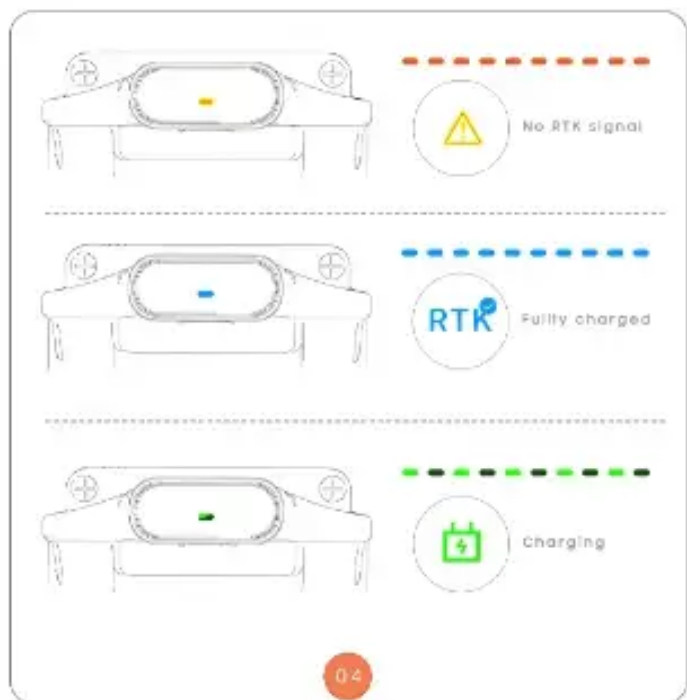
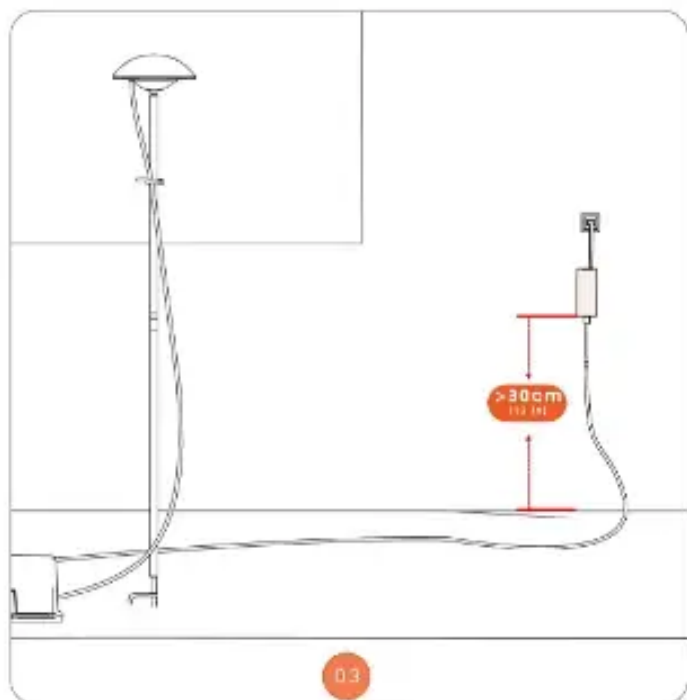
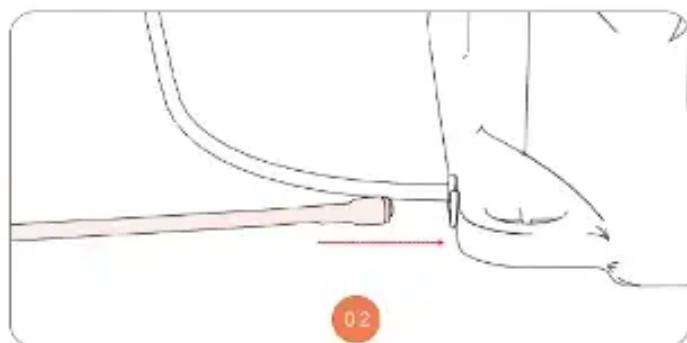
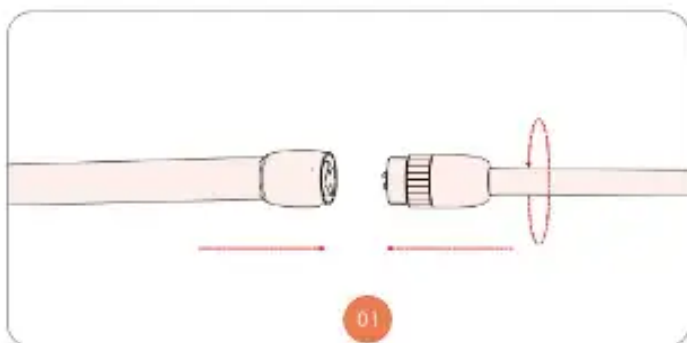

**Activate the Mower** **STEP 5**

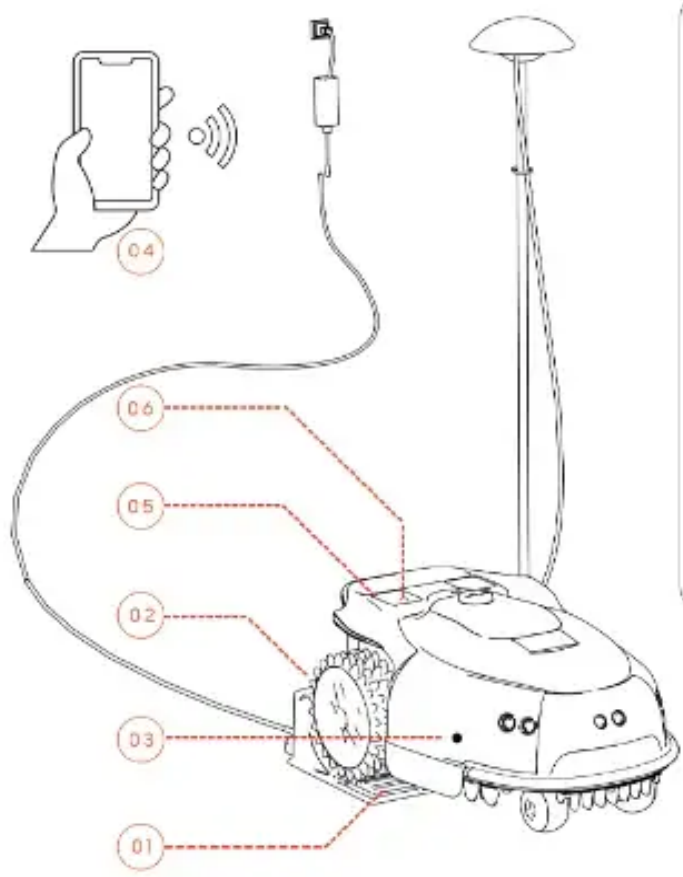

- 01 Fix the charging station.
- 02 Place the mower into station.
- 03 Open power.
- 04 Login to the app to add a lawn mower .
- 05 The display screen shows that Bluetooth is connected .
- 06 LED: Solid Blue.

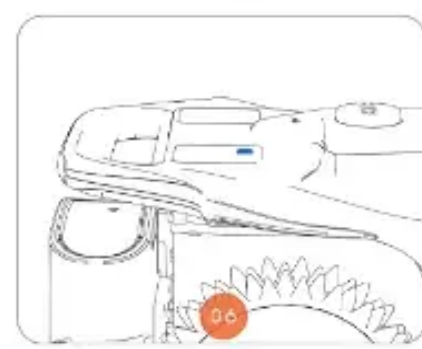
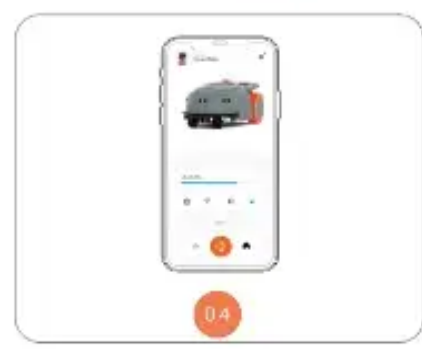
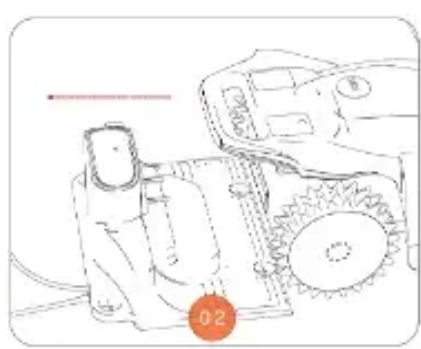
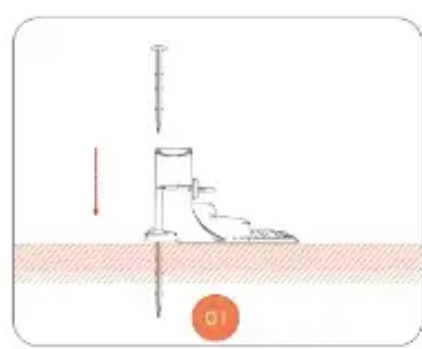



**Set up the boundary** **STEP 6**

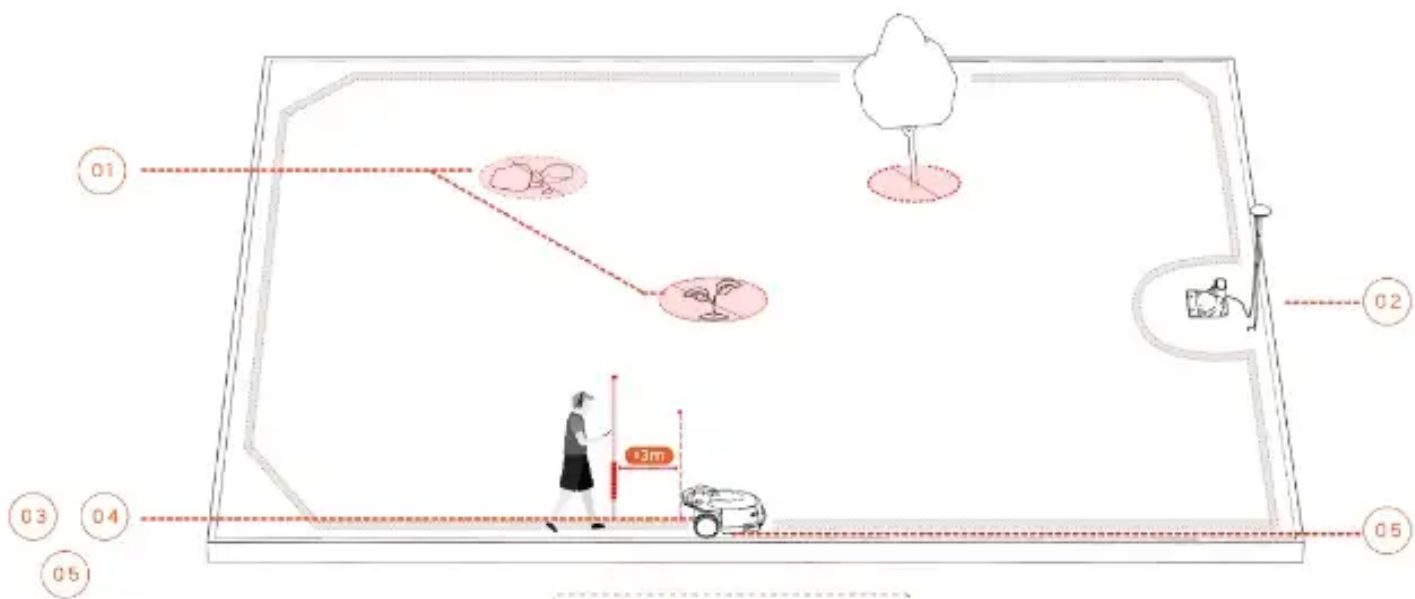

**Map out the Boundary**

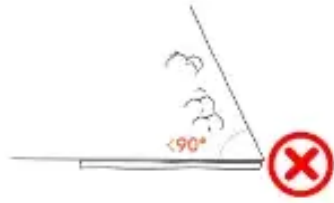
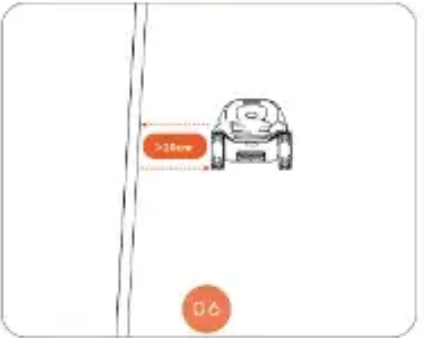
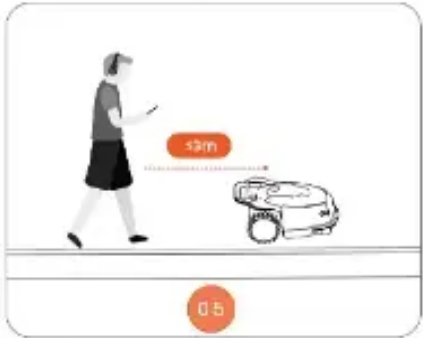
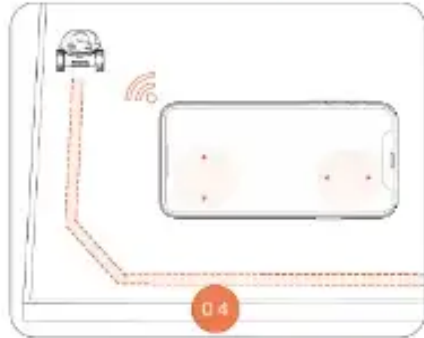
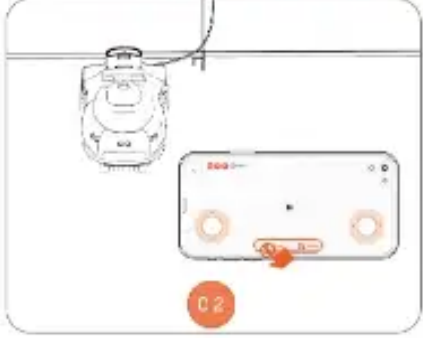

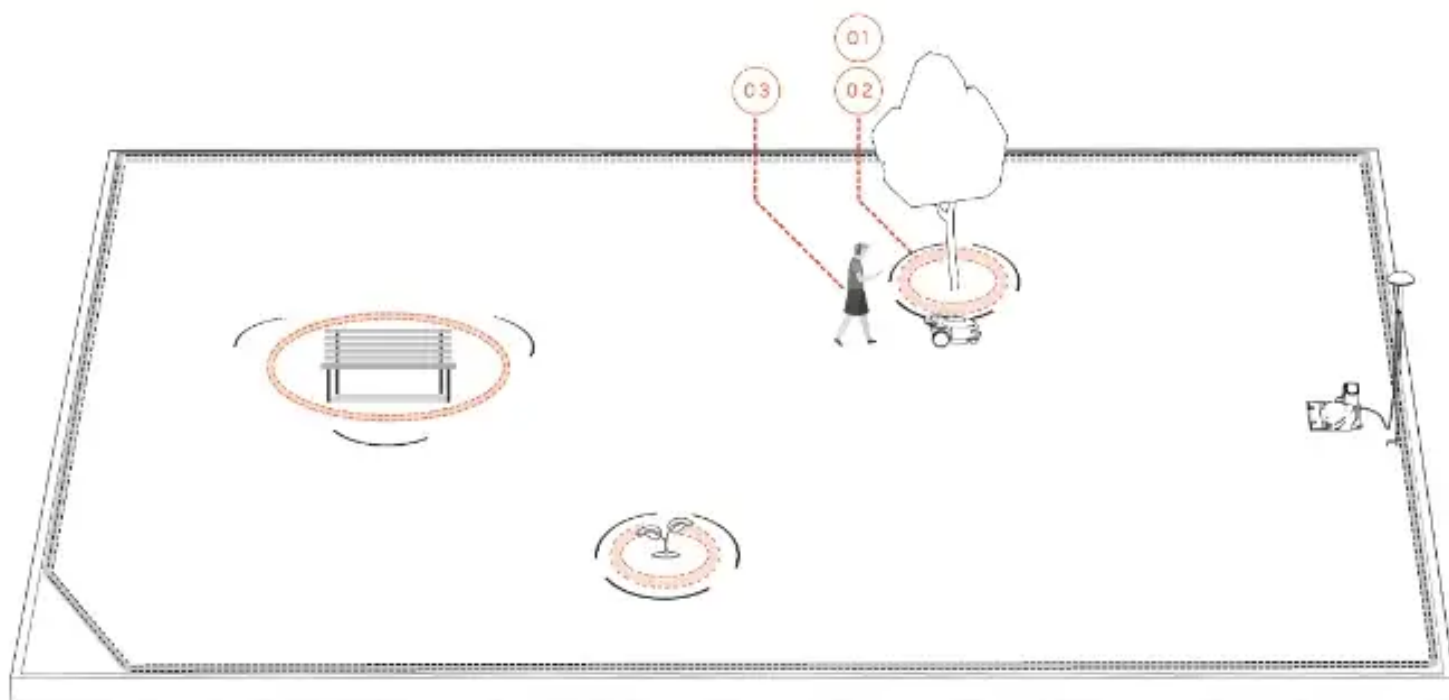

- 01** Remote control the mower to the area where you want to set up No-go zones.
- 02** Select the No-go zone mode in the app.
- 03** Remote control the mower to draw lines and set up No-go zones.

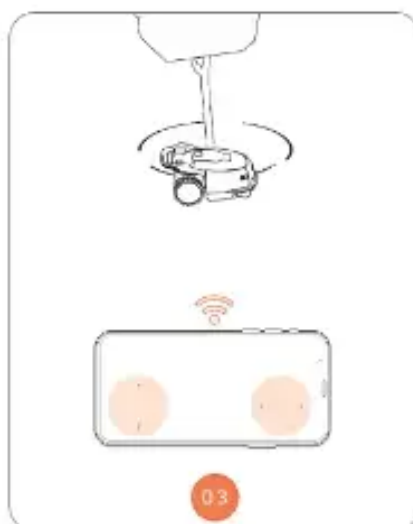
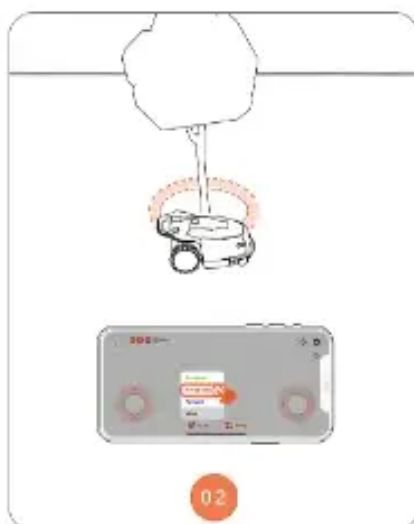



## Create a passage to Link Separate Zones **STEP 8**

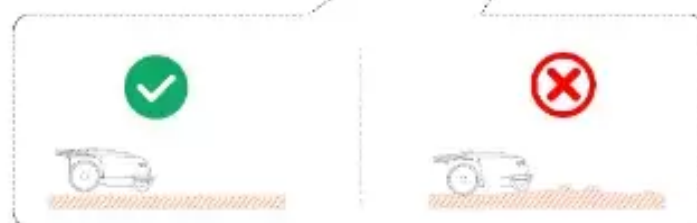
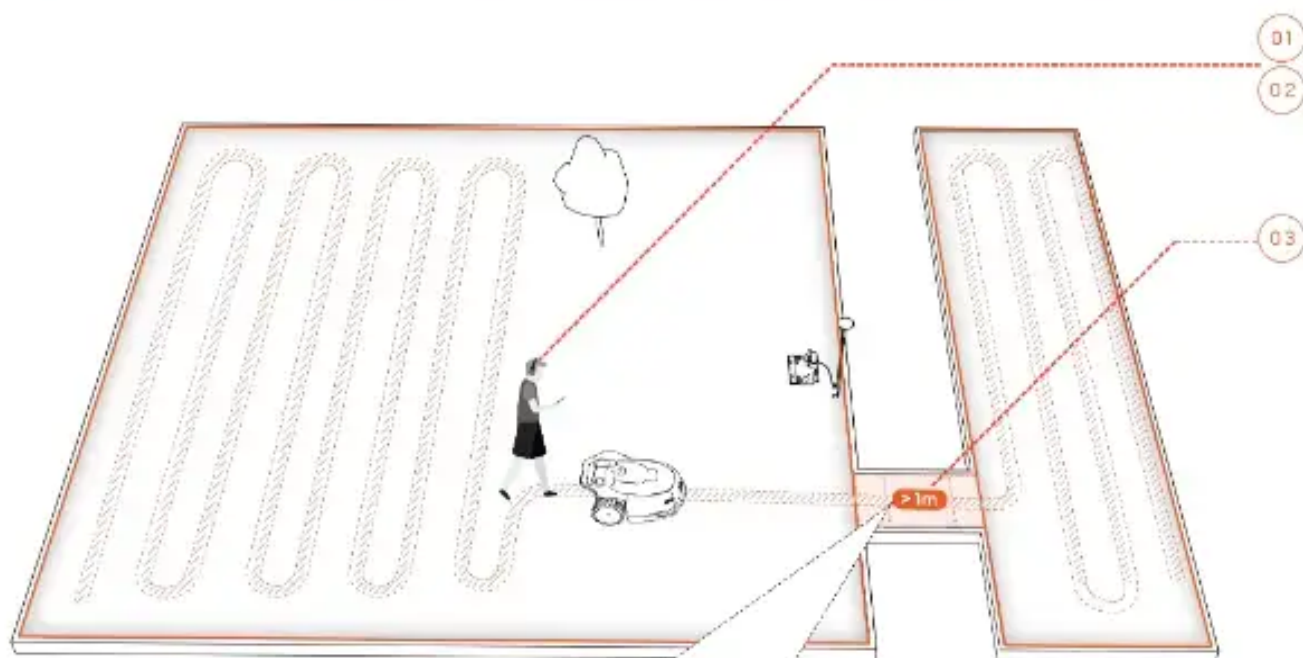

**01** Remote control the Mower to Zone A

**02** Choose the passage mode in APP

**03** Remote control the Mower to Zone B

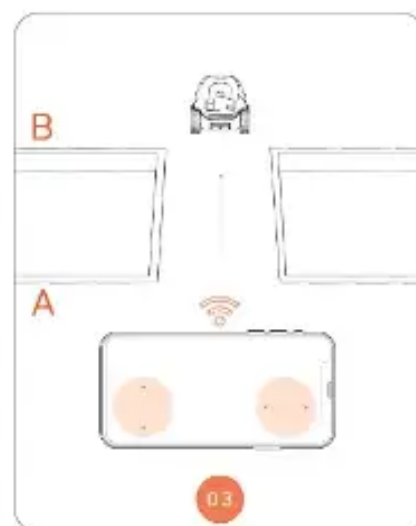
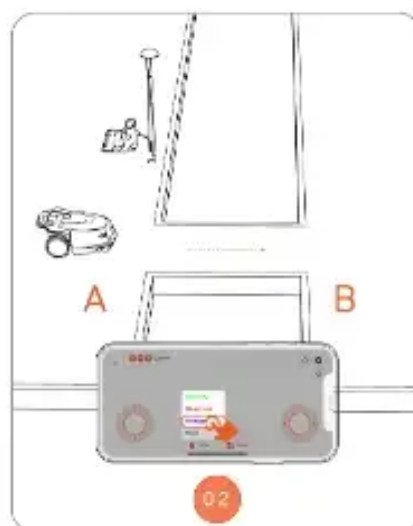
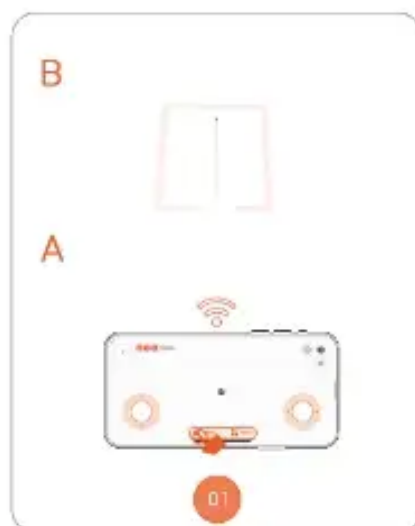



 Save Map **STEP 9**

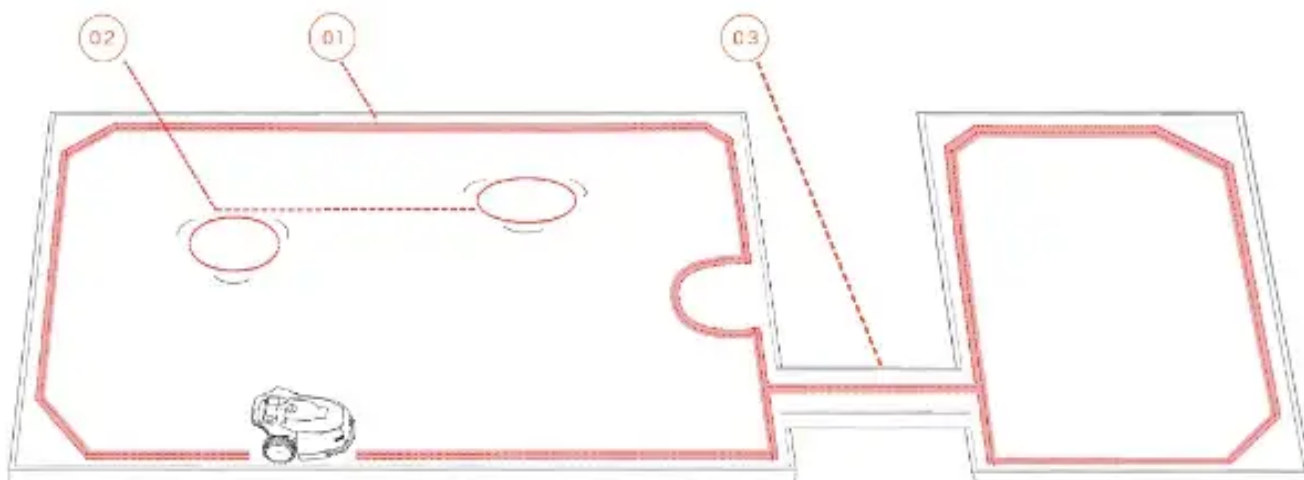

- 01 Boundary .
- 02 No-go zones.
- 03 Passage.

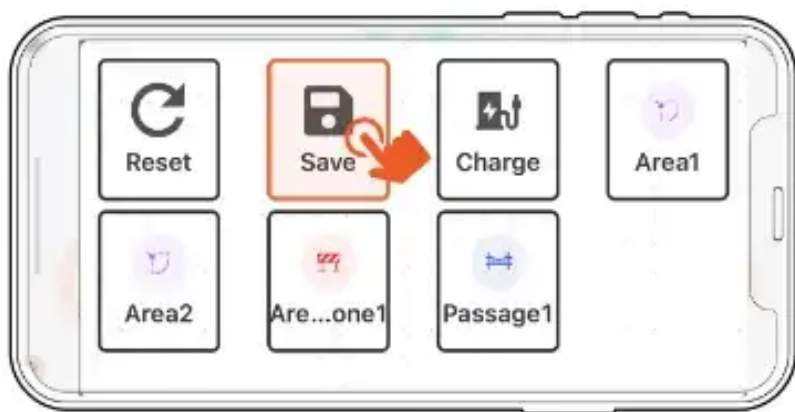

Thank you for choosing our lawn mower.